



Digitrax Command Control
Run Your Trains, Not Your Track!

DN16310

Fits InterMountain N-Scale SD40T
Tunnel Motor Locos

N Scale

**Mobile Decoder
DCC Plug 'N Play
1.5 Amp/2.0 Amp Peak
6 FX³ Functions, 0.5 Amp**

Features:

- **Digitrax LocoMotion® System**-Your locomotives look like the real thing. The Digitrax LocoMotion System makes them run like the real thing, too!
 - Torque Compensation** for smooth as silk silent operation.
 - 128 Speed Step** operation (14 or 28 steps can also be used).
 - Momentum** with acceleration and deceleration.
 - Normal Direction of Travel** is user selectable.
 - Switching Speed** feature for easier and faster access to yard speeds.
 - 3 Step Speed Tables** set start, mid and max voltage for custom control.
 - 28 Step Speed Tables** with 256 level resolution for precise control.
- **Scalable Speed Stabilization (Back EMF)** with simple setup & 256 level resolution.
- **SuperSonic** motor drive for silent operation.
- **FX³ Functions** for prototypical lighting effects:
 - Constant Brightness Lighting** with directional or independent control.
 - Realistic Effects** like Ditch lights, Mars lights, strobes, and many more.
 - Dynamic and Static Qualifiers** operate functions based on direction, F0 on or off, loco direction and F0, and whether loco is moving.
 - Function Remapping** of 14 functions for custom function setup.
 - Master Light Switch** turns off all lights & functions with one keystroke.
 - Advanced Consist Function Controls**
- **Plug 'N Play** design makes installation quick and easy.
- **Golden-White LEDs** for added realism.
- **Transponder equipped** ready for transponding on your layout.
- **All Mode Programming with Operations Mode Read Back**-read back CV values right on the mainline.
- **Decoder Factory CV Reset** with or without speed table initialize.
- **Motor Isolation Protection** prevents damage to your loco and decoder.
- **Basic, Advanced & UniVersal Consisting**
- **2 Digit and 4 Digit Addressing**
- **DCC Compatible**
- **FCC Part 15, Class B RFI compliant**



Parts List

1 DN163I0 Decoder

1 Instruction sheet

Installation Information

See the Digitrax Decoder Manual for complete decoder test procedures, installation instructions, programming and technical information. Digitrax manuals and instructions are updated periodically. Please visit www.digitrax.com for the latest versions, technical updates and additional locomotive-specific installation instructions.

Installation Instructions - InterMountain SD40T Locomotive

1. Carefully remove the locomotive's shell from the frame. Notice the orientation of the light board inside so that you can install the decoder in the same orientation.
2. Carefully remove the plastic light shroud at the front of the loco and loosen the frame screws enough to allow the removal of the light board. Lift the board out of the frame.
3. Apply the Kapton insulating tape on the front of frame to completely cover the flat area above the frame screw. Install the decoder, square CPU to the top, between the frame halves. The narrow part of the decoder fits between the frame with the frame clips holding it at the corners of the decoder cutout. The brass motor contacts should contact the pads on the bottom of the decoder. Squeeze the frame halves together to

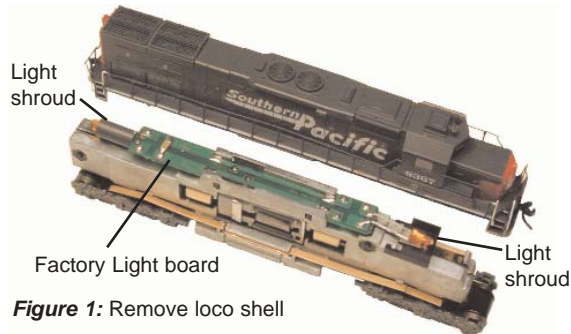

Figure 1: Remove loco shell

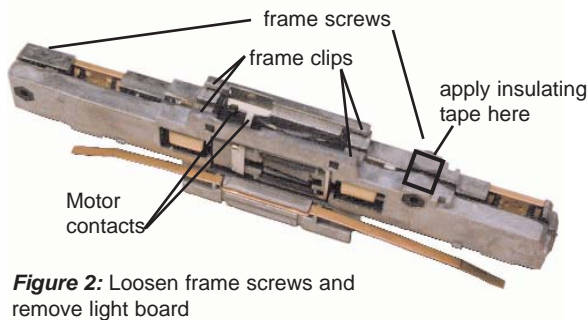

Figure 2: Loosen frame screws and remove light board

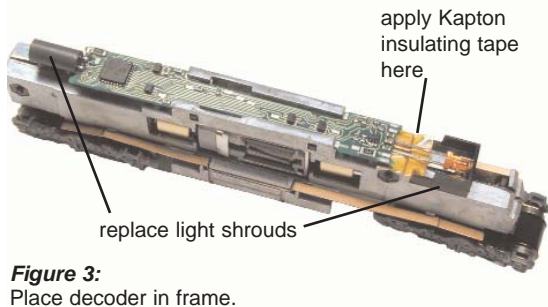

Figure 3: Place decoder in frame.



450 Cemetery Street
Norcross, GA USA 30071
www.digitrax.com

T 770-441-7992
F 770-441-0759
E sales@digitrax.com

hold the decoder in place.

4. Tighten the frame screws. Replace the trucks if they have fallen out during the installation of the decoder. Place the locomotive on the track, select address 03 on your throttle and apply power. If the motor does not respond but you can control the lights, check the installation for motor short circuits.
5. Replace the locomotive shell. Digitrax decoders are set up with configuration variable (CV) default values so you can run your locomotive right away using address 03. See the Digitrax Decoder Manual for complete instructions on setting up the CVs for customizing your locomotive's performance characteristics.

Installation Notes:

1. Do not exceed the decoder's 500mA total function output rating.
2. To use a function output with an inductive (coil) type load, see the Digitrax Decoder Manual for more information to avoid damage to the decoder.
3. See the Digitrax Decoder Manual for full details of wiring 12-16V lamps, 1.5V lamps, and LEDs. Lamps that draw more than 80 mA when running require a 22 ohm 1/4 watt resistor in series with the directional light function lead to protect the decoder.

Customizing Your Decoder

Your Digitrax decoder is ready to run and will operate using address 03 with no additional programming. For a more prototypical railroading experience, your decoder can be customized for your specific locomotive by programming some of the Configuration Variables, or CVs, available. See the Digitrax Decoder Manual or the Digitrax web site for more information.

Changing the Decoder Address

The first CV most people change is the decoder address so that the loco can be independently controlled with it's own unique address. All Digitrax decoders are shipped with CV01 (AD2), the two digit address, set to 03. See your Starter Set Manual for complete programming instructions. Following is a brief description of how to change the decoder address with a DT series throttles.

1. Place the loco on the programming track. Go into Program Mode on your system. On DT400 press **PROG**. On DT300, DT100 & DT200 press **RUN/STOP & FN/F0**.
2. Choose AD2 for 2 digit addressing or AD4 for 4 digit addressing (DT300 & DT400). (Ad for DT100 & DT200, see set manual for 4 digit instructions).
3. Choose the address you want to set up for the decoder.
4. Complete address programming. On DT400 press **ENTER**. On DT300, DT100 & DT200 press **SEL**.

Note: CV29 must also be programmed to enable 4 digit addressing, this is done automatically by the DT300 & DT400 but not on earlier throttles.



Digitrax Command Control
Run Your Trains, Not Your Track!

Digitrax LocoMotion® System

Your locomotives look like the real thing, now you can make them run like the real thing, too. Digitrax decoders incorporate torque compensation for smooth as silk operation. You can also program CVs that control momentum, 3 step and 128 step speed tables, switching speed, normal direction of travel, scaleable speed stabilization and more to take full advantage of the Digitrax LocoMotion System.

Momentum-CV03 & CV04

Acceleration is controlled by CV03 and deceleration by CV04. Both come from the factory set to 000/x00. A range of 000/x00/ to 031/x1F is available for both accel and decel. We recommend that you try CV03:003/x03 and CV04:000/x00 as a starting point for experimenting with momentum.

Speed Tables-How the Loco Responds to the Throttle

With Digitrax LocoMotion, there are two types of speed tables: 3 Step Tables and High Resolution 28 Step Tables. Please see your Decoder Manual for a discussion of the 28 Step Tables. The 3 Step Tables are set up by programming 3 CVs: Start Voltage (CV02), Mid point Voltage (CV06) and Max Voltage (CV05). These values are set at 000/x00 at the factory. All have a range of values from 000/x00 to 255/xFF. We recommend the following CV values as a starting point for experimenting with speed tables.

Loco Type	V Start CV02	V Mid CV06	V Max CV05
Switcher Concentrated low speed. Limited top speed	002/x02	038/x26	064/x50
Road Switcher Prototypical top speed w/evenly distributed curve from 0 to top speed	002/x02	048/x30	098/x62
Mainline Loco Quick increase to cruising speed then levels off to prototypical top speed.	002/x02	128/x80	154/x9A



450 Cemetery Street
Norcross, GA USA 30071
www.digitrax.com

T 770-441-7992
F 770-441-0759
E sales@digitrax.com

Other LocoMotion® Features: Switching Speed, Normal Direction of Travel & Scaleable Speed Stabilization (Back EMF) Features

Switching speed is controlled by CV54. The factory setting is 000/x00 for OFF. To turn on the switching speed feature, program CV54 to a value of 001/x01. When this feature is on, use F6 to activate and deactivate switching speed. When switching speed is ON and F6 is ON, the switching speed feature is on. With the feature on the throttle's target speed is effectively reduced by about 50% and the effects of accel and decel programmed into the decoder are reduced by 1/4. This is useful for yard switching operations.

Normal Direction of Travel is controlled by CV29. See your decoder manual for additional information on the settings for CV29.

Scaleable Speed Stabilization (Back EMF) intensity, or droop, is controlled by CV57. The factory setting for this feature is 006/x06 which is suitable for most locos. You can adjust this value in the range of 000/x00 for OFF to 015/x0F for the maximum effect. Consult your Digitrax Decoder Manual for info about CVs 55 & 56 and their effects on scaleable speed stabilization.

SuperSonic Silent Operation and Torque Compensation

The factory settings in the decoder provide silent, smooth operation of your locomotive under most conditions. For more information about these settings, please see the Digitrax Decoder Manual or our web site.



Function Outputs on the DN16310

The DN16310 is set up at the factory to control six functions. The unit is prewired with two golden-white LEDs set up for directional lighting as F0F/F0F+ for the front light and F0R/F0R+ for the rear light. Functions F1 (Green), F2 (Violet), F3 (Brown) and F4 (White/Yellow) can be used by soldering a wire from the pad for the function you wish to use to the lamp (or other function) you wish to control. The wire colors indicated are the standard color code used in the industry (you can use any color you like). These colors are important if you plan to use function remapping.

CAUTION: When adding function wires, be very careful that the wires you add do not come into contact with any other pads or components on the board where they might create a short circuit.

All six function outputs can be easily set up with Digitrax FX3 lighting effects or as standard on/off functions with the following operational qualifiers:

1. Forward or Reverse direction of travel, or
2. Whether F0 is on or off, or
3. Both direction of travel and whether F0 is on or off, or
4. Whether the locomotive is stopped or moving.

Figure 5: Connecting More Functions to Your DN16310

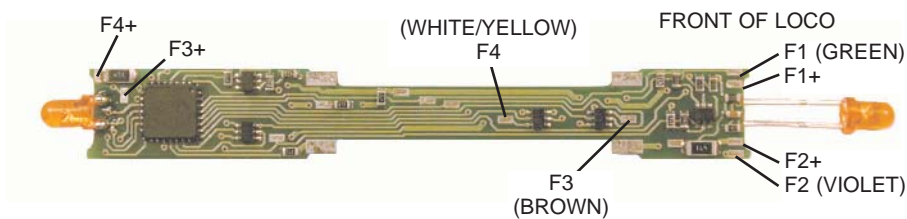

Function Remapping

Function remapping allows you to program the function outputs of your decoder to be controlled by selected function keys on your throttle. Please consult the Digitrax Decoder Manual or website for information on function remapping.



450 Cemetery Street
Norcross, GA USA 30071
www.digitrax.com

T 770-441-7992
F 770-441-0759
E sales@digitrax.com

Digitrax Transponding CV61

Digitrax Transponding is controlled by CV61. The default value is 000/x00 for OFF. To turn on transponding, program CV61 to a value of 002/x02. This allows you to use Digitrax transponding to keep track of your rolling stock.

Decoder Reset CV08

Decoder reset lets you reset all CV values to the factory default settings. To reset all CV values, program CV08 to a value of 008/x08. You also have the option of resetting all values except the 28 speed step tables. To do this, program CV08 to a value of 009/x09.

Warranty & Repair

All warranties on Digitrax products are limited to refund of purchase price, repair or replacement at Digitrax's sole discretion. Except as expressly stated in the full warranty statement, there are no warranties, express or implied, including but not limited to any warranties of merchantability or fitness for a particular purpose. For complete warranty details see www.digitrax.com.

Damaged decoders should be returned directly to Digitrax for repair.

Caution: To prevent damage to your decoder and locomotive, track voltage used during operation must not exceed the operating parameters of the locomotive and its lighting system in which the decoder is installed (typically this is 12V DC). For most N scale layouts, Digitrax recommends using 14 volts DCC or less for operation to avoid damage to the locomotive shell, lamps and decoder.

Digitrax, Inc. is not responsible for unintentional errors or omissions in this document.



DN16310

Plug and Play Decoder for InterMountain N-Scale SD40T Tunnel Motor Locomotives

Movin' Down The Tracks With Digitrax® Digitrax Command Control

Main Station

Starter Sets
LocoNet
Power Supplies



Your Digitrax LocoNet® Starter Set is just the beginning of an exciting trip! Pick the one that's right for you!



LocoNet®
The Digitrax Difference

Locomotive Shops

Mobile Decoders
Function Decoders

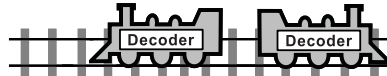

More Fun For Everyone

Add More Boosters, Advanced & Simple Throttles, Power Supplies, Universal Panels, IR and/or Radio for more trains and operators.

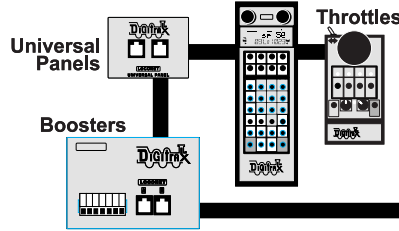

Maintenance Of Way

Make your layout more fun & simpler to operate!

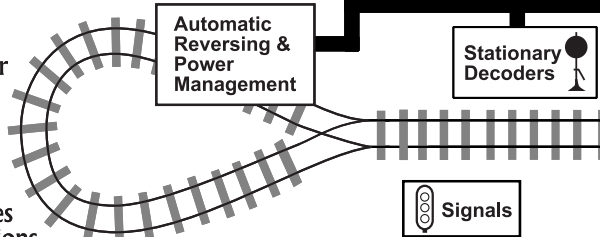

Computer Controls

PDA Throttles & Applications
Computer Interfaces
Programmer

Putting It All Together

The Digitrax Big Book of DCC

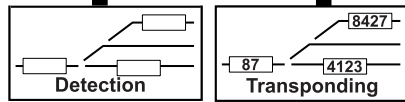

Made in U.S.A.



450 Cemetery Street
Norcross, GA USA 30071
www.digitrax.com
T 770-441-7992
F 770-441-0759
E sales@digitrax.com

DN16310



6 52667 05033 3

307-3008-0000 1K/12/03